

Stand Alone PV House Design for Maximum Power Output in Sydney Australia Metropolitan Area

M. Nassereddine, J. Rizk, A. Hellany, M. Nagrial
School of Computing, Engineering & Mathematics
Western Sydney University
Penrith, Australia
mnassereddine@ieee.org

A. Elrafhi, Z. Obeid, K. Hajar
School of Engineering
University of Technology and applied Science
Tripoli, Lebanon
Ahmad_rafhi@ulf.edu.lb

Abstract— Nowadays, a strong link exists between human comfort and electrical power. Abundant doings are not possible without the support of the electrical energy. Driven by the human obligation to save the environment, the installation of PV solar system increased dramatically in the past numerous years. The installation can be grid connected or standalone system. These micro-grid situations are installed world-wide and currently are contributing to the local electrical network. To maximize the use of the generated solar system, numerous system installed energy storage in the form of batteries. These energy storages harvest the sun power during daylight to support the household electrical demand after sunset. This paper linked the house roof design to the PV solar system for maximum generation condition. Furthermore the paper contains important information on the optimum location for the solar panel to ensure continuous and reliable system is achieved. An actual real case study is presented.

Index Terms—Electrical Power, Energy Storage, House Consumption, PV System.

I. INTRODUCTION

The installation of solar PV system is accelerating worldwide. Numerous countries support financially the installations of small PV system for house or industrial use. For example, in Australia, the government provides rebates for installing PV solar system, grid connected or stands alone, on the roof of residential or industrial properties.

The micro-grid installation at the residential properties supports the local network by injecting the surplus power into the utility network. Taking into consideration the fact that PV micro-grid produces maximum power during the midday period on a sunny day. The house peak demands hours are located in the morning and late in the afternoon/evening [1, 2]. Based on the mentioned information, the micro-grid generated power doesn't support the house critical electrical requirements.

Electrical power storage is required to harvest the sun power during the day to support the electrical apparatus during the night time. Due to the cost and life time of available energy storage, numerous researchers discussed numerous approaches to enhance the system efficiency and extend the light of the proposed storage system.

The paper provides information regarding the stand alone house requirements. The assessment includes numerous

approaches on how to design an advanced architect of an efficient PV system with storage facility. Furthermore, the paper shows how the house building design can play a vital role to ensure maximum power is harvested from the sun. The presented case study is based on the constructed and commissioned standalone PV house in Sydney Australia metropolitan area.

II. THEORETICAL STUDY

Driven by the greenhouse effect and United Nation Goal 7 [3], the installation of the PV solar system for residential properties increased in the past decades. PV panels generated power changes throughout the year. Figures 1 and 2 show the average hourly solar distribution, and the electrical loading for residential customers [1, 2]. It is clearly shown that the generated power requires energy storage to support the house daily (24 hours period) electrical consumptions.

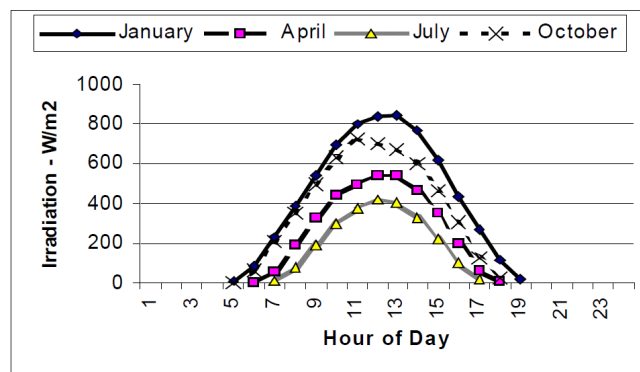

Fig. 1. Solar Hourly Energy distribution [1]

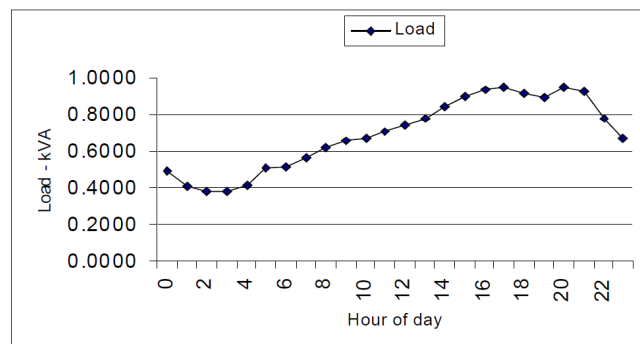

Fig. 2. Electrical loading for residential property [1]

The energy generated by the solar panel during the sun-light period supports the running electrical appliances and charge the batteries to support the electrical demand during the sun-set period. Based on this information, the size of the PV solar system and battery storage is critical to ensure system reliability and availability.

The standalone design in this paper is divided into the following sections:

- House orientation and roof layout
- Solar panels system sizing and layout
- Energy storage sizing
- House electrical distribution circuits

A. House Orientation and Roof Layout

The house orientation, roof space and tilt play an important role for the PV solar system. The PV solar panel maximum output power is obtained if the panel is installed perpendicular to the sun light. This can only be achieved if the roof supports such installation. For example, in Sydney, the sun path is shown in fig. 3. The figure also highlights the inadequate sun light exposure for PV panels facing the south. Furthermore, the figure shows that the sun angle to the panel changes, the angle depends on the seasons. For example, in spring, the optimum tilt angle is 34 degree while in summer is 16 degrees.

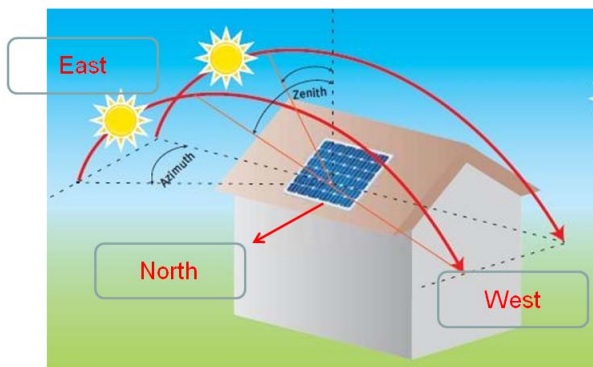

Fig. 3. Sun path for Sydney Australia

Based on the above information, the roof design (tilt and space) plays an important role for the house maximum possible power generation. The house electrical appliances and its operating sequence form one of the main inputs for the roof design. Take Sydney house as an example, if the critical house electrical demands is for the afternoon during the winter, the roof design should allow for sufficient space that is facing North-West with 58 degrees tilt angle. The proposed equation 1 in this paper can be used to assist with the roof space design and tilt.

$$\begin{cases} R_S = \left(\frac{H_{C-P}}{PV_p \times H_E} \right) \times A_p \\ T_A = \begin{cases} 16^\circ - \text{Summer} \\ 34^\circ - \text{spring / Autumn} \\ 58^\circ - \text{Winter} \end{cases} \end{cases} \quad (1)$$

Where

R_S is the roof area requirements to support the required critical power during a defined day period

H_{C-P} is the house required critical power during a defined day period

H_E average daily sun exposed hours

PV_p is the single PV panel rated output power (including the efficiency coefficient)

A_p is the single PV area.

T_A is the required tilt angle for the roof and is based on the season that reflect the critical power requirements

B. Solar panels Sizing and Layout

The sizing of the PV panel system depends on the house electrical appliances and its operating pattern. The design should take into consideration the instantaneous power P_i and consumed power P_C . The paper used equation 2 [4] to compute the electrical power disbursed by the house electrical appliances:

$$P_C = K + O + L + G + M + H \quad (2)$$

Where

P_C is the total daily power consumed by the house (Wh)

K is the air-condition power (Wh)

H is the hot water power (Wh)

O is the cooking power (Wh)

L is the lighting power (Wh)

M is the washing and cleaning machines power (Wh)

G is the general power (Wh) (Fridge, hair dryer, mixer....)

The instantaneous power is based on the proposed operation sequence of the electrical appliances. The paper proposed the use of equation 3

$$\begin{cases} E_L = \text{Equipment} - \text{List} - \text{Operating} - \text{same} - \text{time} \\ P_i = \sum E_L \end{cases} \quad (3)$$

Where

E_L is each apparatus rated power (kW)

For example, if M, K and L are running at the same time,
 $P_i = M_i + K_i + L_i$

Where

M_i, K_i & L_i are the instantaneous power of each apparatus in kW

It is worth mentioning, the instantaneous power set the requirements for the charger inverter, PV panels and battery storage. While the consumed power set the requirements for the energy storage. The installed system should be able to support the instantaneous power which means the inverter instantaneous power should match/exceed the house requirements. The inverter instantaneous power is driven by the PV panels and battery instantaneous power capability during the day and the battery instantaneous power capability during the sun-set and heavily cloudy days.

The number of panels is determined based on the consumed power and the number of sun hours. Equation 4 can be used to compute the number of PV panels:

$$N_p = \frac{P_C}{PV_p \times N_H} \quad (4)$$

Where

N_p is the number of minimum panels to support the required electrical load

N_H is the number of sun hours that the panels will be exposed per day

It is worth mentioning, the determination of the electrical power usage per apparatus might require the manufacturer assistance. For example, if a 2.2kW dishwasher running for 2 hours, this doesn't mean it consumes 4.4kWh (more evidences are provided within the case study). Based on this information and to avoid over design (which cost money and space), it is worth requesting the consumption from the manufacturer for a new house or run a test on the existing house appliances.

The location and tilts of the panels determine the level of outputs for a given time of the day and year. The hourly loading consumption chart determines which part of the day the sun energy is critical to ensure continuous and reliable power is available. In addition, this process can also be used to extend the battery storage life cycle. Additional information is provided in the next section.

C. Energy Storage

Based on figures 1 & 2, maximum power demands in the afternoon are not supported by the PV solar generated power. To ensure continuous and reliable of the power supply is provided, energy storage is required as an essential element for the stand alone house. The concept is to store the excessive energy generated during the daylight to support the electrical load after sun-set. Based on this information, the optimum goal is to ensure the battery storage is fully charged by the sun-set or close to it. This provides the house with maximum power storage for the use overnights and the early mornings.

To ensure batteries are fully charged in the evening, the PV panels set up should provide sufficient power in the afternoon to support the house electrical consumptions and ensure the batteries maintain its fully charged power. In addition, fig. 2 shows that the maximum house electrical usage is located in the evening and early hours of the night. Therefore, PV panels facing toward the west support the afternoon power requirements better than the one facing east or north.

Sizing and life of the batteries depends on the following factors:

1. Number of back up days (during these days the battery should support the house electrical demands)
2. Electrical usage after sun-set.

1) Number of back up days

Equation 5 is used in this paper to compute the required battery size to ensure continuous electrical power during the backup days.

$$B_S = \frac{N_D \times P_C}{\zeta_B} \quad (5)$$

Where

B_S is the required battery storage (kWh)

N_D is the required backup days

ζ_B is the battery level of discharge (must be less than 1)

2) Electrical usage after sun-set

Batteries life is measured with cycle, each time the battery is fully discharged, and one life cycle is lost. The house consumptions after sunset (or during heavy cloudy day) utilizes the battery stored energy and start the life cycle clock. Reducing the energy consumption after sunset extends the battery life. This can be achieved by using advance energy management system. More information can be found in the author published paper [4].

D. House Distribution circuit

The house distribution circuit plays an important role to improve system efficiency for standalone houses. Dual electrical bus, direct Current (DC) and Alternating Current (AC) offers higher efficiency system (eliminate the energy requirement to perform the inversion when use DC appliances rated at the system voltage). Numerous household items, such as lighting, can operate on DC power. Fig. 4 represents the paper proposed standalone house distribution circuit.

The advantages of the DC bus can be presented in the following items:

- Removal of the inverter which reduces the losses and the budget

- Choose appliances with operating voltage similar to the battery storage to eliminate the usage of DC/DC converter
- Design the PV array voltage to comply with the acceptable operating limits of the DC apparatus. This reduces the stress on the charger controller and extends its life.
- During sunny clear days, it is possible to run the DC appliances direct from the PV panels
- The charger controllers are cheaper than inverters

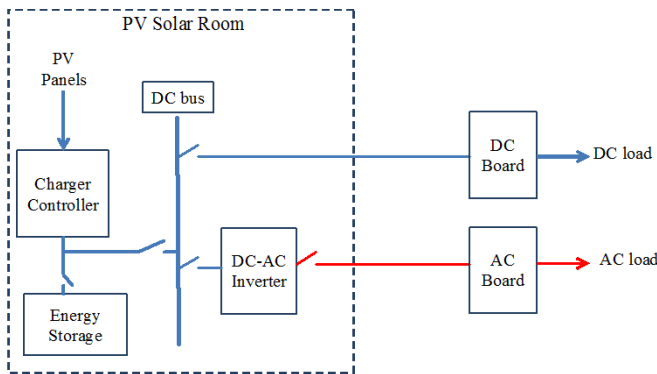

Fig. 4. Dual bus distribution circuit for the standalone house

III. THEORETICAL STUDY DISCUSSION

The theoretical section of this paper highlights the important of the house roof architect design to maximum the sunlight exposure and to suit the timeline critical power demand. This approach supports the following discussion:

- Currently the battery storage cost is high in comparison to the PV panels price
- The battery storage operating life is short in comparison to PV panels.
- The installation of additional PV solar panels allow for:
 - Faster battery charging
 - Support the house hold during cloudy day without the aid of the battery
 - Reduce the battery size for backup days especially in Sydney Australia (It is rare to have a total dark cloudy days in Sydney Australia, Always will be exposure to sunlight (high or low density) during the day

The following example supports the above discussion: if a 10kW solar panels are installed to support the household with 20kWh battery storage, during a cloudy day, if the 10kW panels are operating at 20% for two hours during the day (low sunlight density), the PV panel produces 4kWh during the cloudy day which represents 20% of the battery storage capacity. If only 5 kW solar panels is installed, the output power during the same day is 2kWh which represents only 10% of the battery storage

In addition to the above, the theoretical study introduces equation 1 which assists with the roof design to maximize the power output. Also the analysis captures the orientation of the solar PV panels to support the critical power demands and maximize the use of the battery storage.

IV. CASE STUDY

It is worth mentioning that the case study is based on the design and constructed house in Western Sydney region. The following form the input of the case study:

- The roof foot print of the proposed new house is 13 by 10 meters
- The land orientation is shown in fig. 5
- House electrical appliances:
 - 76 Down Light (DC LED Light)
 - Television (LED)
 - Refrigerator (230V 420kWh/year)
 - Freezer (230V, 360kWh/year)
 - Ducted Air-condition (single-phase 230V, 28A rated current)
 - DC Split Air-condition (48V, 1.2kw)
 - Electric Oven (2.2kW)
 - Electric Cooktop (2kW)
 - Hot water-Heat pump (700W)
 - Washing Machine (450W)
 - Microwave Oven (2.2kW)
 - Kettle (2kW)
 - Hoover (2.2kW)
 - Dishwasher (2.2kW)
- Battery level of discharge is 70%
- Summer average sun hour exposure is 6
- Winter average sun hour exposure is 4
- 250W PV panels to be used
- 1.95m² the area for single panel

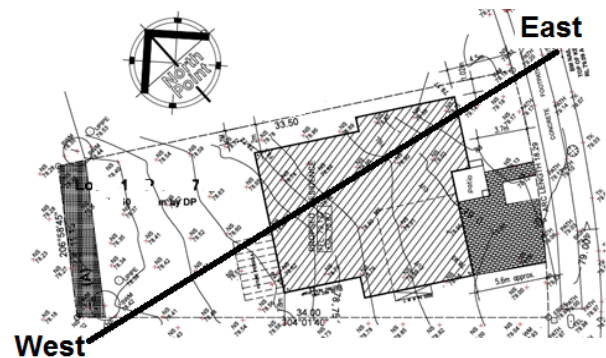

Fig. 5. House orientation in respect to the North

The roof design was an essential decision to ensure the required PV panels are installed to support the house electrical load. The assessment shows that in the maximum daily power consumption is located in the late afternoon period during the summer season. Based on this assessment, the house should have sufficient area to install panels that faces North West. The published works in [4] are used to compute the hourly

electrical consumption for the house. It is worth mentioning the following two items as the experimental results supporting the theoretical statement:

- The dishwasher usually runs for 2.2 hours, therefore, based on the 2.2kW rated power, the consumption is computed to be 4.84kWh (the computation is completed by multiplying the rated power by the number of hours)
- The Oven usually runs for 0.7 hour, the computed consumption power is 1.54kWh

In Sydney Australia, there is no adequate sun exposure for the roof that is tilted and facing south. Therefore, the roof tilt should avoid the south. Fig. 6 shows the proposed roof design along with the tilt of the PV panels.

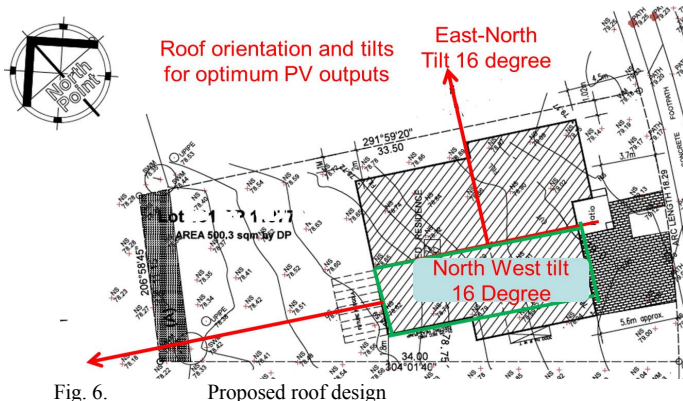

Fig. 6. Proposed roof design

Table 1 summarizes the daily electrical maximum loading with and without the Air-condition. It is worth mentioning that the hot water operates only 4 hours per day.

TABLE I. TABLE I: COMPUTED DAILY ELECTRICAL CONSUMPTION

Details	Morning (kWh) (06:00-10:00)	Midday (kWh) (10:00-14:00)	Afternoon (kWh) (14:00-18:00)	Evening and early night (kWh) (18:00-22:00)	Overnight (kWh) (22:00-06:00)
Electrical consumption with Ducted Air-condition	3.2	16.1 (60% is after 12)	10.6	3.8	2.8
Electrical Consumption without Ducted Air-condition	3.2	2.9	2.1	2.6	2.8

Based on the table 1 data, the maximum daily power consumption with the ducted air-condition is 36.5kWh and the maximum daily power consumption without the ducted air-condition is 13.6kWh. The ducted air-condition will only operate during hot days, which mean the sun is shiny and the PV solar panels generating electrical power. The house PV system is designed based on the followings:

- The PV solar system produces sufficient instantaneous power during sunlight to support the house electrical demands with the presence of the ducted air-condition
- The battery storage is sized to provide two days backup support without the ducted air-condition

Equation one shows an area of 47.45m² is required to install the required 250W panels. This equate to 28 panels.

$$\begin{cases} R_s = \left(\frac{36.5}{0.25 \times 6} \right) \times 1.95 = 47.45m^2 \\ T_A = \{16^0 - Summer\} \end{cases}$$

Table 1 data shows that large consumption is located between 10:00 and 14:00. To ensure the PV output is staggered throughout the day, the system is divided into two sections:

- One facing North East
- One facing North West

It should be noted that the roof design has an area of 90m² available for the panel installation. Taking into consideration the theoretical discussion, the decision was made to install an additional 12 panels which make it's a total of 40 panels that equate to 10kW system.

Equation 5 is used to size the required battery storage:

$$B_s = \frac{2 \times 13.6}{0.7} = 48.85Wh$$

The design used 2V 800AH battery cell to create the 48V 38.4kWh battery bank. The system was installed at the designated property. An energy monitoring system is installed to record the system consumption. Figures 7 and 8 show the house daily maximum instantaneous power as well as the energy consumption. During the day, the system was closely monitored where the followings are observed:

- During the sunny clear day, the output of the PV panel supports the house electrical demand without the use of the energy stored in the battery
- In the evening, the system facing North-West produces around 70% more power to the one facing north east which ensures the house electrical demands is met with minimum battery supports.
- The recorded actual energy consumption for the dishwasher is 45% of the value (4.84kWh) stated during earlier assessment. The monitoring system shows that the dishwasher has numerous cycles where the power increased to 2.2kW for a limited time before it dropped to 0.2kW.
- Similar observation is witnessed for the electric oven

Fig. 9 shows the measured daily instantenous power without the presense of the ducted aircondition. It is cclearly shown the large reduction in the house electrical consumption.

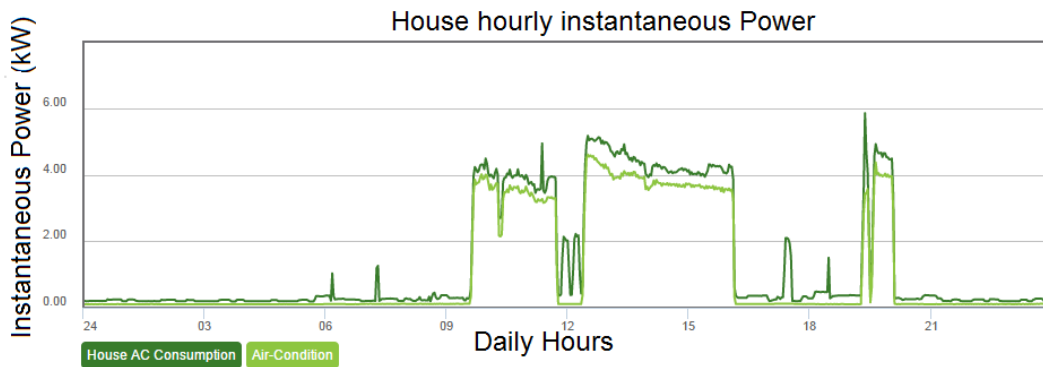

Fig. 7. House hourly instantaneous power with the ducted air-condition

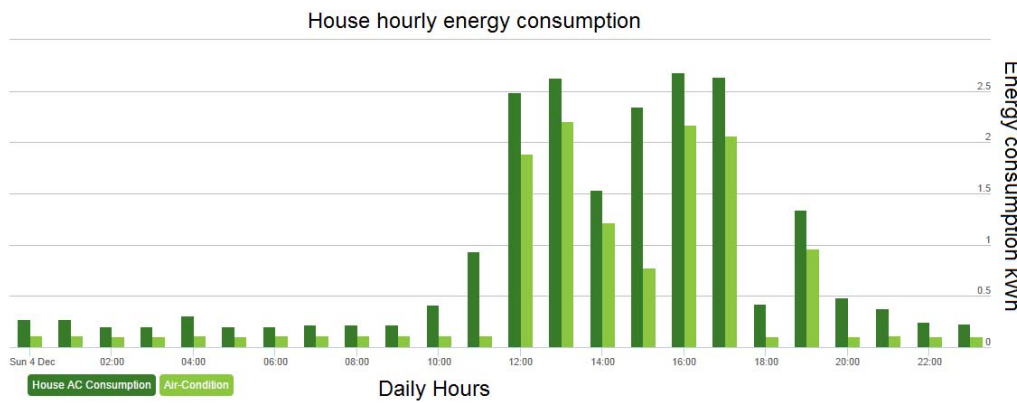

Fig. 8. House hourly energy consumption

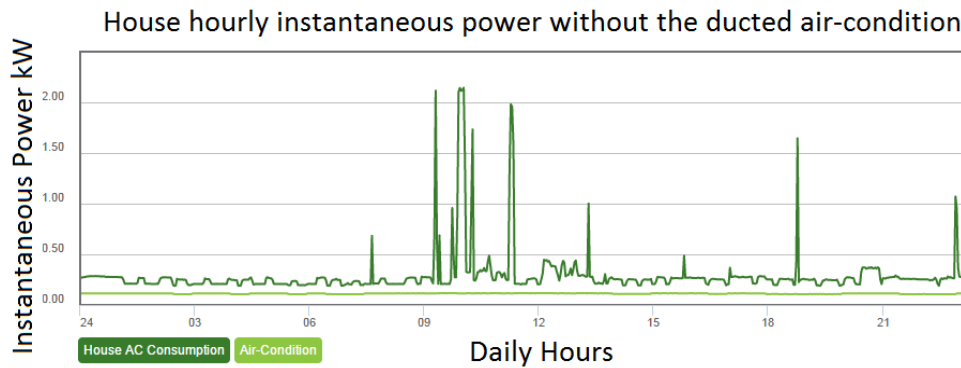

Fig. 9. House hourly instantaneous power without the ducted air-condition

V. CONCLUSION

The physical implementation of the system especially the roof design shows the large area that is made available for the installation of the PV system. Also, installing the panels at different direction assist with continuous power generation throughout the day. The installed system supports the theoretical study and is currently supporting the house since May 2016.

REFERENCES

1. K. Mitchell "Optimisation of the applications of sustainable energy systems" Ph.D. dissertation, School of Engineering and Industrial Design. Univ. Western Sydney. 2005.
2. K. Mitchell, M. Nagrial and J. Rizk "Simulation and optimization of renewable energy systems". Electrical Power and Energy Systems. Vol. 27. PP. 177-177. 2005
3. <https://sustainabledevelopment.un.org/sdg7>. Accessed on 2-12-2016 at 2:30PM
4. M.Nassereddine, J. Rizk, A. Hellany, M. Nagrial, A. Elrafhi, Z. Obeid and K. Hajar "Electrical Energy Management for advance smart home systems: Introduction" 3rd International Conference on Renewable Energies for Developing Countries (REDEC), July, Lebanon 2016.