

# Kinematic and dynamic analysis and distribution of stress for four-item mechanism

Ján Vavro Jr.<sup>1\*</sup>, Ján Vavro<sup>1</sup>, Petra Kováčiková<sup>1</sup>, Juliána Vršková<sup>1</sup>

<sup>1</sup>Faculty of industrial Technologies in Púchov, Alexander Dubček University of Trenčín, I. Krasku 491/30, 020 01 Púchov, Slovak Republic

**Abstract.** This paper presents a kinematic and dynamic analysis and distribution of the stress for four-item planar mechanism by means of the SolidWorks software. Graphic dependence of kinematic and dynamic magnitudes of some points is given in dependence on the angle of rotation of the driving item and in dependence on the time. Distribution of the stress in the items is presented in [ Pa ]. In relation to the kinematic and dynamic analysis and subsequent simulation of the planar as well as spatial mechanisms, it is great solution to use SolidWorks software program. The considerable advantage of this mentioned program is based on its simplicity from the aspect of modeling and moreover, it is important to point out that utilisation of the mentioned program leads to results which are precise and accurate in the case of the numerical solution of the equations in the whole magnitude referring to motion of mechanism while the given results are obtained in the graphic form.

**Keywords:** kinematic analysis, dynamic analysis, finite element method, planar mechanism

## 1 Introduction

The main objective of the kinematic and dynamic analysis of the four-item planar mechanism in the SolidWorks program was closely connected with the investigation of the position deviation tolerance, the convergence speed of equation solutions for the each one specified position of the planar mechanism. The mentioned analysis will be used for comparison of the obtained results with the results, which will be obtained by help of any other commercial software systems.

## 2 Kinematic and dynamic analysis of planar mechanism

The planar mechanism representative (Fig. 1) consists of four bodies and it was used as computational model. Using the kinematic analysis [4-6] and dynamic analysis and subsequent simulation [1-3], the main objective is connected with the determination and entering of the position domains, speed (velocity) domains as well as acceleration of the individual bodies in relation to the specified input values of the angular velocity for the

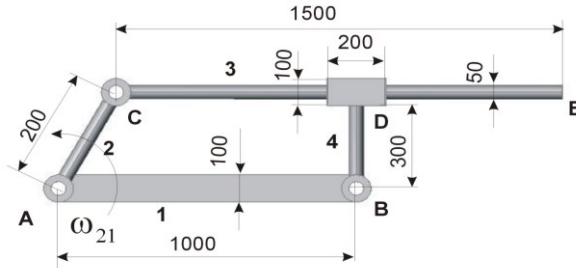
---

\* Corresponding author: [jan.vavro.jr@fpt.tnuni.sk](mailto:jan.vavro.jr@fpt.tnuni.sk)

Reviewers: Radim Halama, Milan Žmindák

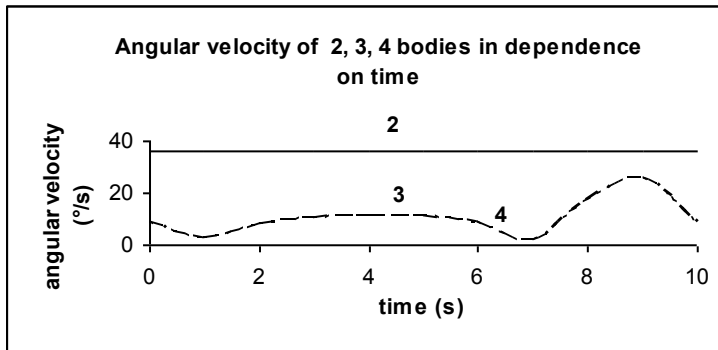
driving body designated as 2. The angular velocity for the body, designated as 2, is specified in this way:  $\omega_{21}=36$  [°/s], where  $\omega_{21}=36$  [°/s] is constant and it is changed in dependence on time (Fig. 2).

Specified input values can be seen in (Fig. 1).

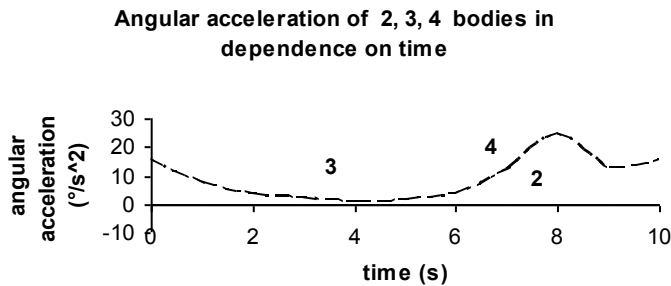


**Fig. 1.** Planar mechanism – computational model

Course of input value for angular velocity can be seen in Fig. 2 and angular acceleration of 2, 3, 4 bodies in dependence on time can be seen in Fig. 3.

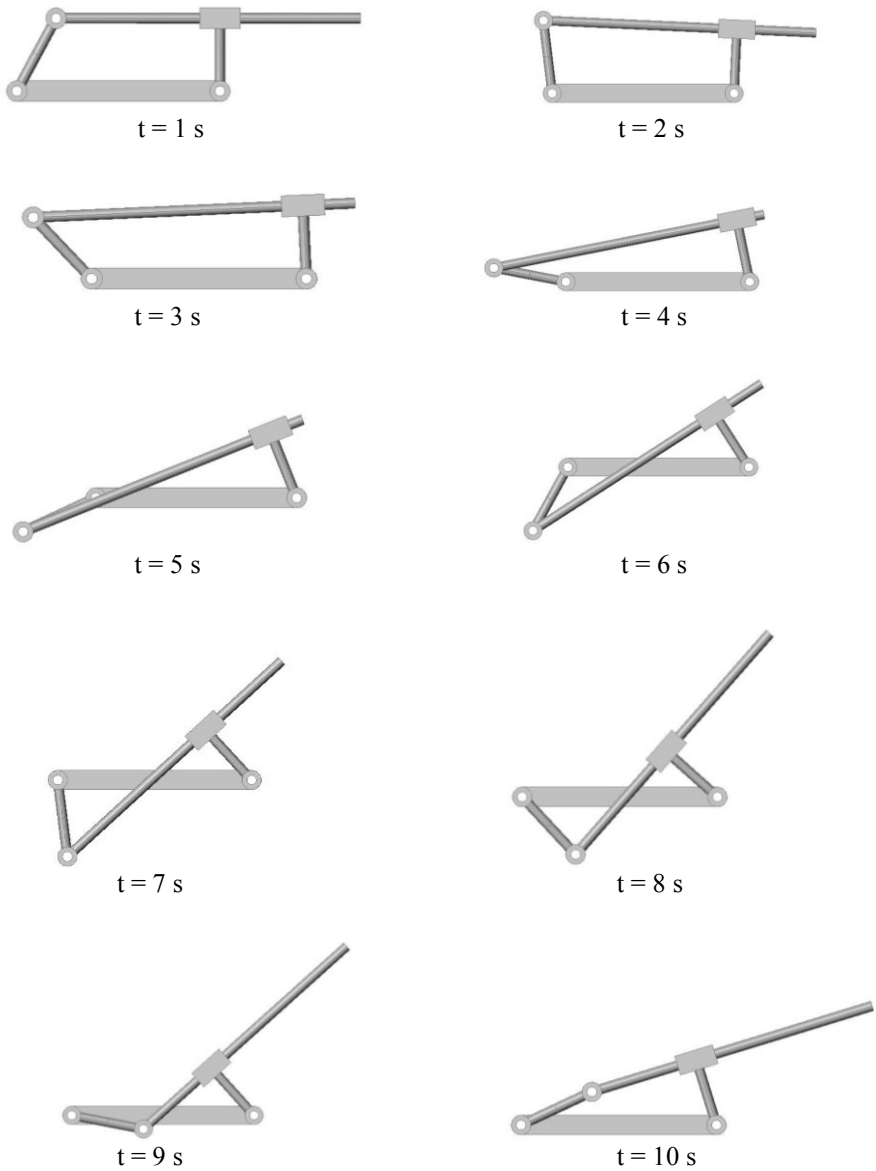


**Fig. 2.** Angular velocity of 2, 3, 4 bodies in dependence on time



**Fig. 3.** Angular acceleration of 2, 3, 4 bodies in dependence on time

The simulation [12] of operation relating to planar mechanism can be seen in the Fig. 4 for time step referring to one second while the whole simulation takes place for ten seconds.



**Fig. 4.** Simulation of planar mechanism operation for ten positions

The whole course of the velocity and acceleration for C, D, E points of bodies can be seen in Fig. 5 and Fig. 6.

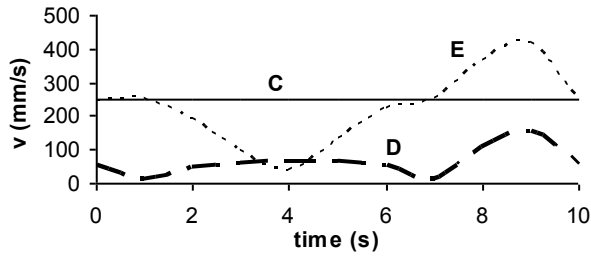


Fig. 5. Velocity in points (C, D, E) - dependent on the time

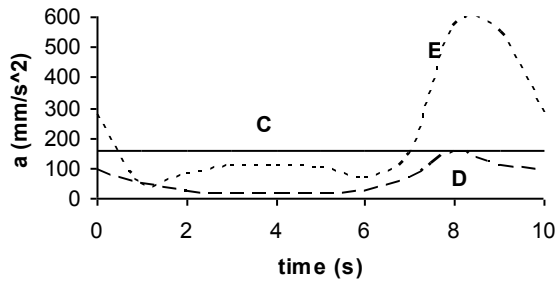


Fig. 6. Acceleration in points (C, D, E) - dependent on the time

The main objective of the dynamic analysis is connected with specification of the loading for the individual items and determination of the courses relating to mutual reactions, referring to individual kinematic connections [7], [10-11]. Fig. 7 represents the course of the reaction in C point of the body, designated as 2 and Fig. 8 represents the course of the reaction in B point of the body, designated as 4.

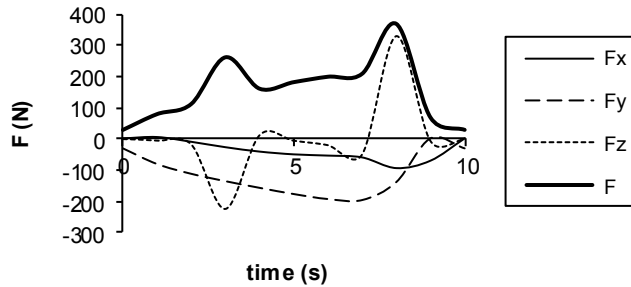
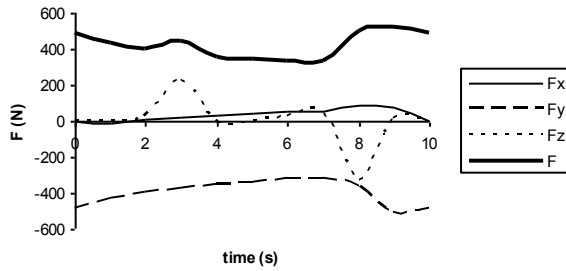


Fig. 7. Course of the reaction in C point of the body, designated as 2 - dependent on the time

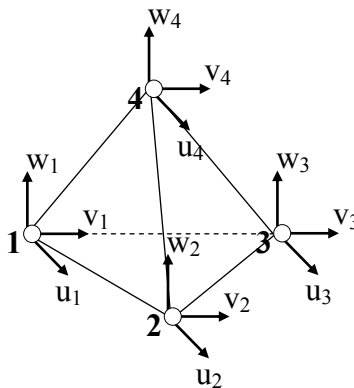


**Fig. 8.** Course of the reaction in B point of the body, designated as 4 - dependent on the time

### 3 Type of finite elements and material properties

The analysis of the planar mechanism was based on selection of the linear tetrahedral element with four nodes (see Fig. 9). The mentioned element belongs among the basic types of the volume finite elements. Including three shifts for each node, twelve deformation degrees of the freedom for the given element were defined. Considering the fact, which is mentioned above, the vector of unknown nodal shifts, can be presented by the equation (1).

$$\mathbf{u} = [u_1 \quad v_1 \quad w_1 \quad u_2 \quad v_2 \quad w_2 \quad u_3 \quad v_3 \quad w_3 \quad u_4 \quad v_4 \quad w_4]^T. \quad (1)$$



**Fig. 9.** Tetrahedral space element

The analysis was based on utilisation of the linear model. Relating to the analysis, the other important values were utilised:

- modulus of elasticity (Young's modulus):  $E = 2.1 \cdot 10^{11}$  (Pa),
- Poisson's ratio:  $\mu = 0.3$ ,
- density of material:  $\rho = 7850$  (kg.m<sup>-3</sup>).

## 4 Distribution of the stress in items of planar mechanism

The distribution of the stress for linked bodies [8-9], designated as 1, 2, 3, 4 can be seen in Figs. 10-17.

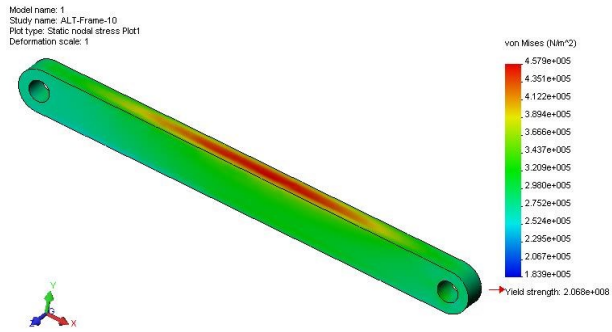


Fig. 10. Distribution of the stress for body designated as 1 in [Pa]

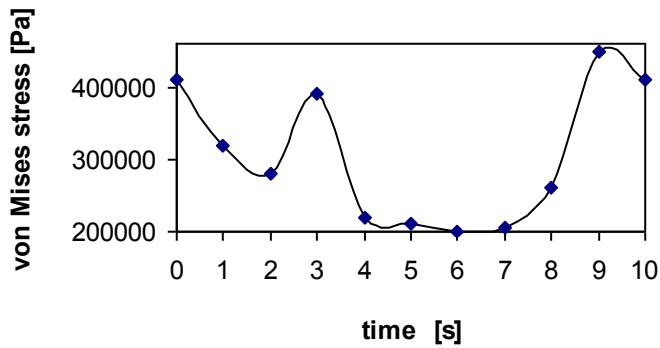


Fig. 11. Course of the stress for body, designated as 1- dependent on the time

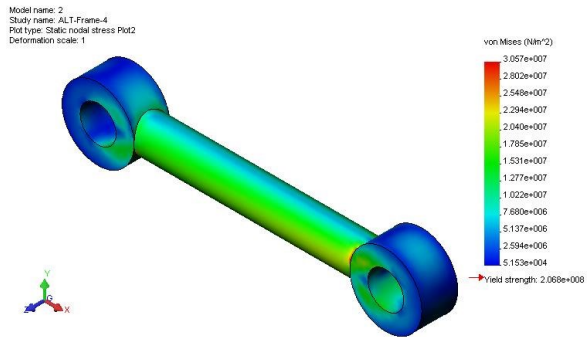
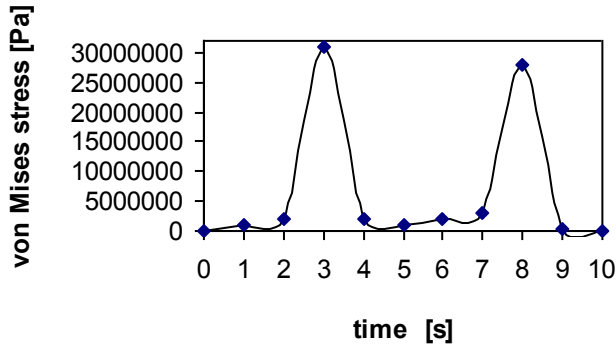
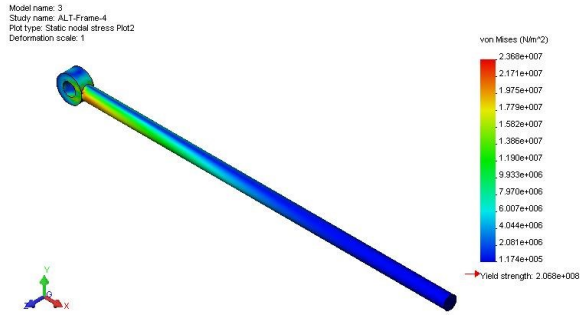


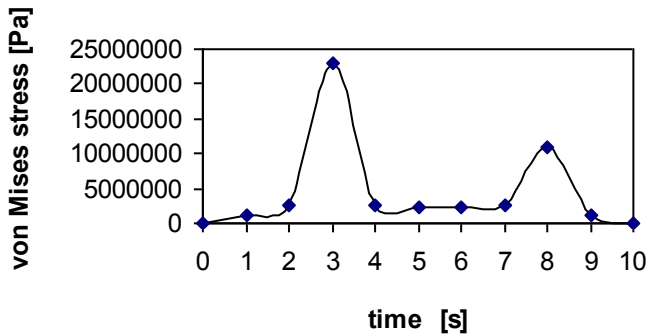
Fig. 12. Distribution of the stress for body, designated as 2 in [Pa]



**Fig. 13.** Course of the stress for body, designated as 2- dependent on the time



**Fig. 14.** Distribution of the stress for body, designated as 3 in [Pa]



**Fig. 15.** Course of the stress for body, designated as 3- dependent on the time

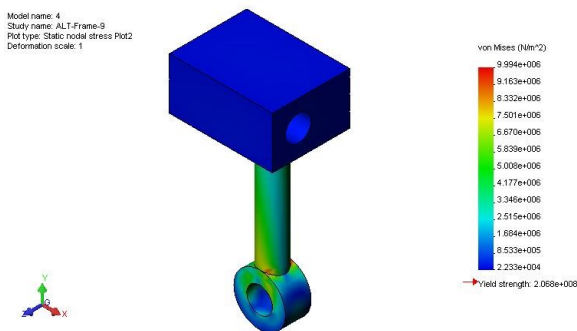


Fig. 16. Distribution of the stress for body, designated as 4 - in [ Pa ]

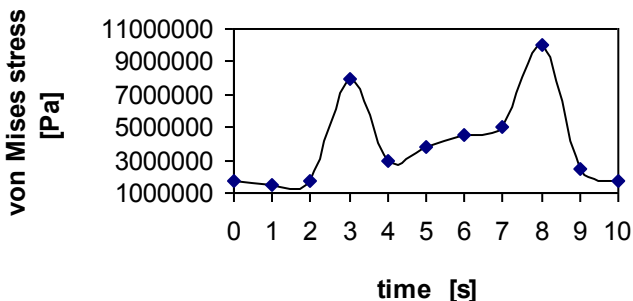


Fig. 17. Course of the stress for body, designated as 4 - dependent on the time

## Conclusion

Based on the evaluation of the results, the utilisation of the Motion Program is significantly useful because it is effective way to determine all kinematic parameters of any mechanism and moreover, the loading for any point of the body system is able to be specified. The tolerance for the position deviation was also tested while the predetermined deviation was  $10^{-9}$ . It is important to point out that from the aspect of convergence, it was not necessary to use more than five steps for each one position. On the other side, the convergence failure was connected with specification and entering of inaccurate parameters.

This work was supported by the Slovak Grant Agency VEGA 1/0649/17, VEGA 1/0589/17, KEGA 007TnUAD-4/2017, and resulted from the project “Center for quality testing and diagnostics of materials”, ITMS code 26210120046 relating to the Operational Program Research and Development funded from European Fund of Regional Development.



## References

1. B. Paul, *Kinematics and Dynamics of Planar Machinery*. (Prentice-Hall, New Jersey, 1979)
2. V. Brát, *Handbook of kinematics with examples*. (SNTL, Prague, 1976)
3. A. Sapietová, M. Sága, B. Hyben, M. Sapieta, *Effectivity methods of parameters refinement of machinery in the program MSC ADAMS*. Applied Mechanics and Materials **611**, 67-74 (2014)
4. A. Sapietová, M. Sapieta, B. Hyben, *Document Sensitivity analysis application for multibody system synthesis*. Applied Mechanics and Materials **420**, 68-73 (2013)
5. A. Sapietová, M. Sága, P. Novák, R. Bednár, J. Dižo, *Design and application of multi-software platform for solving of mechanical multi-body system problems*. Mechatronics: Recent technological and scientific advances, 345-354 (2011)
6. A. Sapietová, V. Dekýš, M. Vaško, *A numerical model of rotating machine having unbalance and the measurements of its dynamical properties*. Metalurgija (Metalurgy) **49**, 503-507 (2010)
7. L. Jakubovičová, M. Sága, *Computational analysis of contact stress distribution in the case of mutual stewing of roller bearing rings*. Novel Trends in Production Devices and Systems, Applied Mechanics and Materials **474**, 363-368 (2014)
8. F. Klimenda, J. Soukup, M. Zmindak, *Deformation of Aluminium Thin Plate*. Manufacturing Technology **16**, ISSN 1213-2489, 124-129 (2016)
9. M. Sága, R. Bednár, M. Vaško, *Contribution to modal and spectral interval finite element analysis*. Vibration Problems ICOVP 2011, Springer Proceedings in Physics **139**, 269-274 (2011)
10. M. Handrik, P. Kopas, V. Baniari, M. Vaško, M. Sága, *Analysis of stress and strain of fatigue specimens localised in the cross-sectional area of the gauge section testing on bi-axial fatigue machine loaded in the high-cycle fatigue region*. Procedia Engineering **177**, 516-519 (2017)
11. J. Zapoměl, V. Dekýš, P. Ferfecki, A. Sapietová, M. Sága, M. Žmindák, *Identification of material damping of a carbon composite bar and study of its effect on attenuation of its transient lateral vibrations*. Int. Journal of Applied Mechanics **7** (6), (2015)
12. I. Delyová, D. Hroncová, P. Frankovský, *Analysis of Simple Mechanism Using MSC Adams*. Manufacturing Technology **14**, ISSN 1213-2489, 141-145 (2014)